

MCD205 Compact Disc Changer



MCD205

The lightning flash with arrowhead, within an equilateral triangle, is intended to alert the user to the presence of uninsulated "dangerous voltage" within the product's enclosure that may be of sufficient magnitude to constitute a risk of electric shock to persons.



AVIS RISQUE DE CHOC ELECTRIQUE - NE PAS OUVRIR.

The exclamation point within an equilateral triangle is intended to alert the user to the presence of important operating and maintenance (servicing) instructions in the literature accompanying the appliance.

WARNING - TO REDUCE RISK OF FIRE OR ELECTRICAL SHOCK, DO NOT EXPOSE THIS EQUIPMENT TO RAIN OR MOISTURE.

NO USER-SERVICEABLE PARTS INSIDE. REFER SERVICING TO QUALIFIED PERSONNEL.

To prevent the risk of electric shock, do not remove cover or back. No user serviceable parts inside.

CAUTION - Invisible Laser Radiation when open. DO NOT stare into the beam or view directly with optical instruments. Use of controls or adjustment or performance of procedures other than those specified in the Owners Manual may result in Hazardous Radiation Exposure.

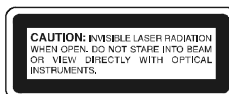

LUOKAN 1 LASERLAITE KLASS 1 LASER APPARAT

VAROITUS! Laitteen käyttäminen muulla kuin tassa käyttöohjeessa mainitulla tavalla saattaa altistaa käyttäjän turvallisuusluokan 1 ylittävälle näkymättömälle lasersäteilylle.

VARNING! Om apparaten används på annat sätt än i denna bruksanvisning specificerats, kan användaren utsättas för osynlig laserstrålning, som överskrider gransen för laserklass 1.

This product incorporates an embedded **CLASS 1 Laser (CFR).**

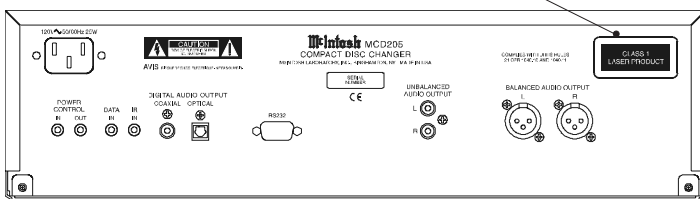
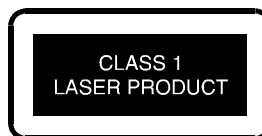
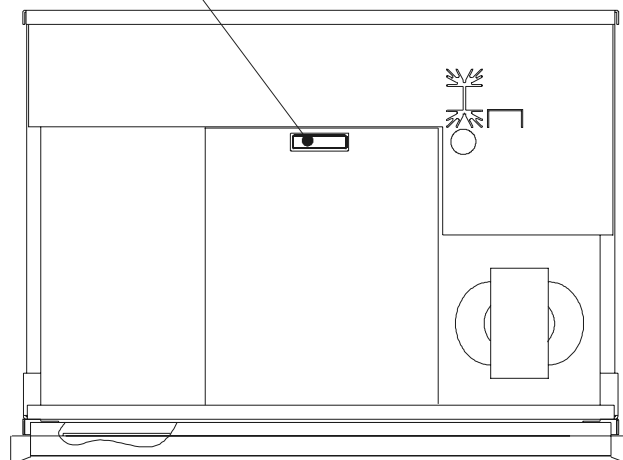

IMPORTANT SAFETY INSTRUCTIONS!

PLEASE READ THEM BEFORE OPERATING THIS EQUIPMENT.

General:

1. Read these instructions.
2. Keep these instructions.
3. Heed all warnings.
4. Follow all instructions.
5. **Warning: To reduce risk of fire or electrical shock, do not expose this equipment to rain or moisture. This unit is capable of producing high sound pressure levels. Continued exposure to high sound pressure levels can cause permanent hearing impairment or loss. User caution is advised and ear protection is recommended when playing at high volumes.**
6. **Caution: to prevent electrical shock do not use this (polarized) plug with an extension cord, receptacle or other outlet unless the blades can be fully inserted to prevent blade exposure.**
Attention: pour prevenir les chocs electriques pas utiliser cette fiche polarisee avec un prolongateur, une prise de courant ou un autre sortie de courant, sauf si les lames peuvent etre inserees afond ans en laisser aucune partie a decouvert.
7. Unplug this equipment during lightning storms or when unused for long periods of time.
8. Only use attachments/accessories specified by the manufacturer.

Installation:

9. The equipment shall be installed near the AC Socket Outlet and the disconnect device shall be easily accessible.
10. Do not block any ventilation openings. Install in accordance with the manufacturer's instructions.
11. Do not install near any heat sources such as radiators, heat registers, stoves, or other equipment (including amplifiers) that produce heat.
12. Do not use this equipment near water.
13. Do not expose this equipment to dripping or splashing and ensure that no objects filled with liquids, such as vases, are placed on the equipment.
14. Use only with the cart, stand, tripod, bracket, or table specified by the manufacturer, or sold with the equipment. When a cart is used, use caution when moving the cart/equipment combination to avoid injury from tip-over.



Connection:

15. Connect this equipment only to the type of AC power source as marked on the unit.
16. Protect the power cord from being walked on or pinched particularly at plugs, convenience receptacles, and the point where they exit from the equipment.
17. Do not defeat the safety purpose of the polarized or grounding-type plug.
A polarized plug has two blades with one wider than the other. A grounding type plug has two blades and a third grounding prong. The wide blade or the third prong are provided for your safety. If the provided plug does not fit into your outlet, consult an electrician for replacement of the obsolete outlet.
18. Do not overload wall outlets, extension cords or integral convenience receptacles as this can result in a risk of fire or electric shock.
19. To completely disconnect this equipment from the AC Mains, disconnect the power supply cord plug from the AC receptacle.

Care of Equipment:

20. Clean only with a dry cloth.
21. Do not permit objects or liquids of any kind to be pushed, spilled and/or fall into the equipment through enclosure openings.
22. Unplug the power cord from the AC power outlet when left unused for a long period of time.

Repair of Equipment:

23. Refer all servicing to qualified service personnel. Servicing is required when the equipment has been damaged in any way, such as power-supply cord or plug is damaged, liquid has been spilled or objects have fallen into the equipment, the equipment has been exposed to rain or moisture, does not operate normally, or has been dropped.
24. Do not attempt to service beyond that described in the operating instructions. All other service should be referred to qualified service personnel.
25. When replacement parts are required, be sure the service technician has used replacement parts specified by McIntosh or have the same characteristics as the original part. Unauthorized substitutions may result in fire, electric shock, or other hazards.
26. Upon completion of any service or repairs to this product, ask the service technician to perform safety checks to determine that the product is in proper operating condition.

Thank You

Your decision to own this McIntosh MCD205 Compact Disc Changer ranks you at the very top among discriminating music listeners. You now have “The Best.” The McIntosh dedication to “Quality,” is assurance that you will receive many years of musical enjoyment from this unit.

Please take a short time to read the information in this manual. We want you to be as familiar as possible with all the features and functions of your new McIntosh.

Please Take A Moment

The serial number, purchase date and McIntosh Dealer name are important to you for possible insurance claim or future service. The spaces below have been provided for you to record that information:

Serial Number: _____

Purchase Date: _____

Dealer Name: _____

Technical Assistance

If at any time you have questions about your McIntosh product, contact your McIntosh Dealer who is familiar with your McIntosh equipment and any other brands that may be part of your system. If you or your Dealer wish additional help concerning a suspected problem, you can receive technical assistance for all McIntosh products at:

McIntosh Laboratory, Inc.
2 Chambers Street
Binghamton, New York 13903
Phone: 607-723-1545
Fax: 607-723-3636

Customer Service

If it is determined that your McIntosh product is in need of repair, you can return it to your Dealer. You can also return it to the McIntosh Laboratory Service Department. For assistance on factory repair return procedure, contact the McIntosh Service Department at:

McIntosh Laboratory, Inc.
2 Chambers Street
Binghamton, New York 13903
Phone: 607-723-3515
Fax: 607-723-1917

Table of Contents

Safety Instructions	2
Thank You	4
Please Take a Moment	4
Technical Assistance and Customer Service	4
Table of Contents	4
Connector Information	5
Introduction and Performance Features	5
Dimensions	6
Installation	7
Rear Panel Connections and Switch	8
How to Connect Control, Analog and Digital Audio	9
Front Panel Indicator, Push-Buttons and Switch	10
Front Panel Display	11
Remote Control Push-Buttons	12
How to Operate the Remote Control	13
How to Operate	14
Specifications	18
Packing Instruction	19

General Notes

- The following Connecting Cable is available from the McIntosh Parts Department:
Data and Power Control Cable Part No. 170-202
Six foot, shielded 2 conductor, with 1/8 inch stereo mini phone plugs on each end.*
- For additional connection information, refer to the owner's manual(s) for any component(s) connected to the MCD205 Compact Disc Changer.*
- The MCD205 basic transport functions may also be controlled by using the remote control that comes with a McIntosh Control Center or Preamplifier. McIntosh Keypads connected to a McIntosh Control Center or Preamplifier will also allow remote operation.*
- Before moving or transporting the MCD205 Compact Disc Changer, remove all CD Discs to prevent possible damage to the MCD205 Transport and/or Discs.*
- The MCD205 Compact Disc Player is designed to play all standard CD Discs that conform to the Official Compact Disc Standards which is indicated by the  Symbol. It will also play most CD-R discs, however some CD-Rs may not be able to play due to the condition of the recording. CD-RWs re-recordable type Compact Discs will not play in the MCD205.*
- The following Discs will not play properly in the MCD205 and should not be tried, as possible damage may occur:
A. Compact Discs 3 inches (8 centimeters) in diameter (e.g. CD Singles).
B. Compact Discs that are not round (e.g. Novelty discs with octagonal or heart shapes).*
- The following list of Compact Disc Accessories should not be used with the MCD205:
A. Compact Disc Stabilizers.*

General Notes, con't

B. Disc Protectors.

C. Lens/Laser Cleaning Discs and devices.

8. Before playing a Compact Disc in the MCD205 for the first time, check each disc to make sure that it doesn't have extra plastic particles (flash) on either the inside center hole or outer circumference. Also if the Compact Disc has a stick-on-label attached, make sure there is no excess glue on either the inside center hole or outer circumference of the disc. Disc(s) inserted into the MCD205 with either of the above conditions could result in improper operation of the MCD205 and possible need for service.

Connector Information

XLR Connectors

Below is the Pin configuration for the XLR Balanced Output Connectors on the MCD205. Refer to the diagram for connection:

- PIN 1: Shield/Ground
- PIN 2: + Input
- PIN 3: - Input

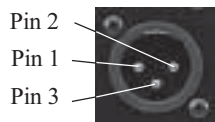

Power Control Connector

The MCD205's Power Control Input/Output Jacks provide Power On/Off Signals when connected to other McIntosh Components. A 1/8 inch stereo mini phone plug is used for connection to the Power Control Input/Output on the MCD205.

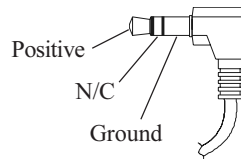

Data and IR Input Port Connectors

The MCD205's Data Port Output provides Remote Control Signals. A 1/8 inch stereo mini phone plug is used for connection to the Data Port Inputs on McIntosh Source Units. The IR Ports also use a 1/8 inch stereo mini phone plug and allow the connection of other brand IR Receivers to the MCD205.

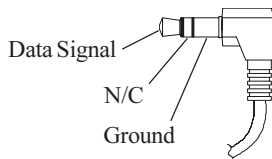

Introduction

The McIntosh MCD205 Compact Disc Changer offers the latest in audio technology and provides state of the art reproduction of Audio Compact Discs. A full complement of performance features provides for ease of operation and the convenience of handling five compact discs at one time. The advanced mechanical design of the transport ensures many years of smooth trouble free operation.

Performance Features

• Advanced Transport

The new MusicBank™ Mechanism with direct loading, provides safe and gentle disc handling for up to five discs. The playing surface of the disc is never touched by the mechanism, only the outside edges of the disc.

• 24 BIT Digital to Analog Converters

The MCD205 utilizes 24-bit D/A converters that offer wide dynamic range with extremely low distortion. Music at all levels is reproduced with extreme precision and elegance. The sound is truly exceptional.

• Balanced and Unbalanced Outputs

Stereo Balanced and Unbalanced Outputs are provided.

• Four Playback Modes

The MCD205 Compact Disc Player allows for Single Disc Play, All Disc Play, Program Play and Random Playback.

• Program Playback

The MCD205 Compact Disc Player allows for playing of the desired Disc and Tracks. The choices are stored into nonvolatile memory so, even if there is an interruption of AC Power, the desired Program Playback is not lost.

• Front Panel Display

The Display indicates the Disc, Track and Time information along with the Playback Mode in use.

• Remote Control Operation

A Remote Control is included that allows for complete control of major functions. The RS232 Control Port allows for connection to other remote control devices.

• Remote Power, Data Control and External IR Input

Remote Power Control In/Out allows the MCD205 to turn On/Off with a McIntosh Control Center. The Data Port Input allows Remote Control Operation from another McIntosh Component. The IR Input allows for the connection of an IR Receiver.

• Special Power Supply

A fully regulated Power Supply with a special R-Core Power Transformer, ensures stable noise free operation even though the power line varies.

MCD205 Dimensions

The following dimensions can assist in determining the best location for your MCD205. There is additional information on the next page pertaining to installing the MCD205 into cabinets.

Front View of the MCD205



Rear View of the MCD205

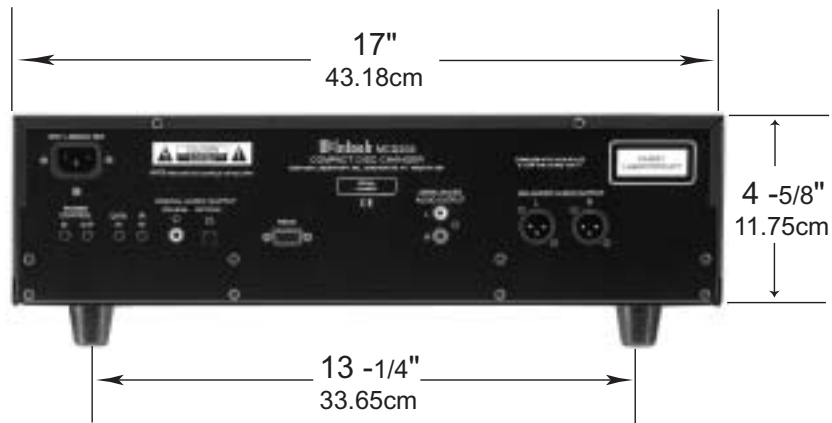

Side View of the MCD205

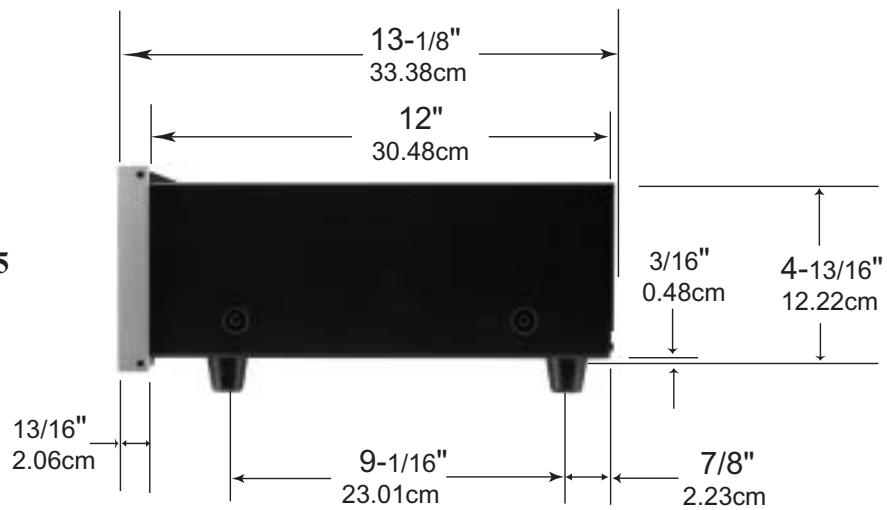

Installation

The MCD205 can be placed upright on a table or shelf, standing on its four feet. The four feet may be removed from the bottom of the MCD205 when it is custom installed as outlined below. The four feet together with the mounting screws should be retained for possible future use if the MCD205 is removed from the custom installation and used free standing. It also can be custom installed in a piece of furniture or cabinet of your choice. The required panel cutout, ventilation cutout and unit dimensions are shown.

Always provide adequate ventilation for your MCD205. Cool operation ensures the longest possible operating life for any electronic instrument. Do not install the MCD205 directly above a heat generating component such as a high powered amplifier. If all the components are installed in a single cabinet, a quiet running ventilation fan can be a definite asset in maintaining all the system components at the coolest possible operating temperature.

A custom cabinet installation should provide the following minimum spacing dimensions for cool operation. Allow at least 2 inches (5.08 cm) above the top, 2

inches (5.08cm) below the bottom and 1 inch (2.54 cm) on each side of the CD Changer, so that airflow is not obstructed. Allow 15 inches (38.1 cm) depth behind the front panel. Allow 1 inch (2.54 cm) in front of the mounting panel for clearance. When a Compact Disc is inserted into the slot opening, the panel clearance required in front of mounting panel is 3-3/4 inches (9.5cm). Be sure to cut out a ventilation hole in the mounting shelf according to the dimensions in the drawing.

MCD205 Front Panel Custom Cabinet Cutout

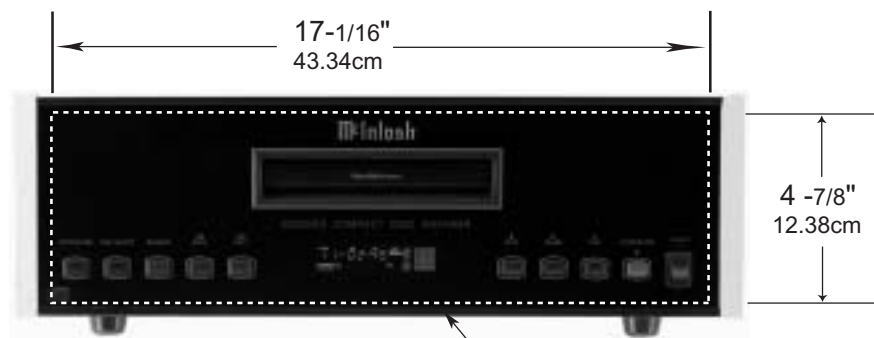

Cutout Opening for Custom Mounting

MCD205 Side View in Custom Cabinet

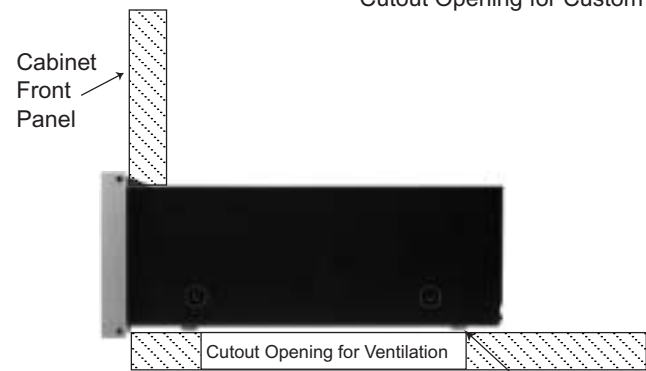

MCD205 Bottom View in Custom Cabinet

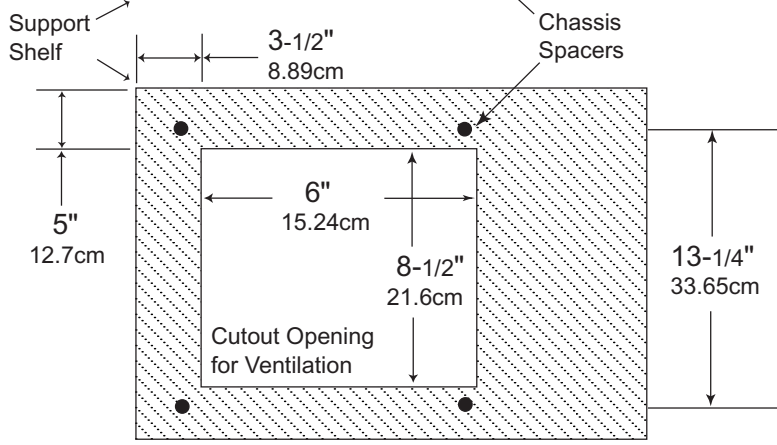

Connect the MCD205 power cord to a live AC outlet. Refer to information on the back panel to determine the correct voltage

DIGITAL OPTICAL AUDIO OUTPUT sends signals to a Control Center/Preamplifier with a D/A Converter

IR INput for connecting an IR Receiver

UNBALANCED AUDIO OUTPUTs contain analog stereo signals to connect to Unbalanced inputs of other components

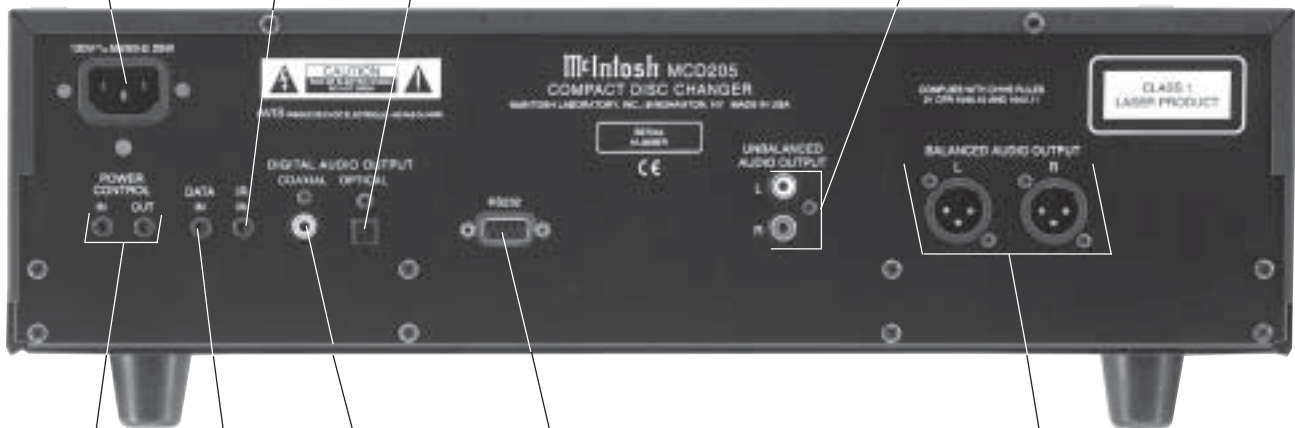

DATA IN receives operating data from a McIntosh Control Center

RS232 connector for connection to a remote control device

BALANCED AUDIO OUTPUTs contain analog stereo signals to connect to Balanced inputs of other components

POWER CONTROL IN receives turn-On signals from a McIntosh Component and POWER CONTROL OUT sends turn-On signals on to another McIntosh Component

DIGITAL COAXIAL AUDIO OUTPUT sends signals to a Control Center/Preamplifier with a D/A Converter

How to Connect

1. Connect a Power Control Cable from the MCD205 POWER CONTROL IN Jack to the POWER CONTROL ACC Output Jack of a McIntosh Control Center/Preamplifier.

Note: If there are other McIntosh Source Components in the system, connect the MCD205 POWER CONTROL OUT Jack to the POWER CONTROL IN Jack on the next source component.

2. Connect a Data Cable from the MCD205 DATA IN Jack to the CD1 DATA Jack on the McIntosh Control Center/Preamplifier.

Note: This connection permits the MCD205 Disc Changer to be controlled remotely from the McIntosh Control Center/Preamplifier and any Zones connected to them.

3. Connect Audio Cables from the MCD205 L and R BALANCED AUDIO OUTPUTS to the CD1 BALANCED AUDIO INPUTS on a McIntosh Control Center/Preamplifier.

Note: An optional connecting method is to use an appropriate cable from one of the MCD205 DIGITAL OUTPUTS to the Digital Input of a McIntosh Control Center/Processor.

4. Connect the MCD205 Power Cord to a live AC outlet.

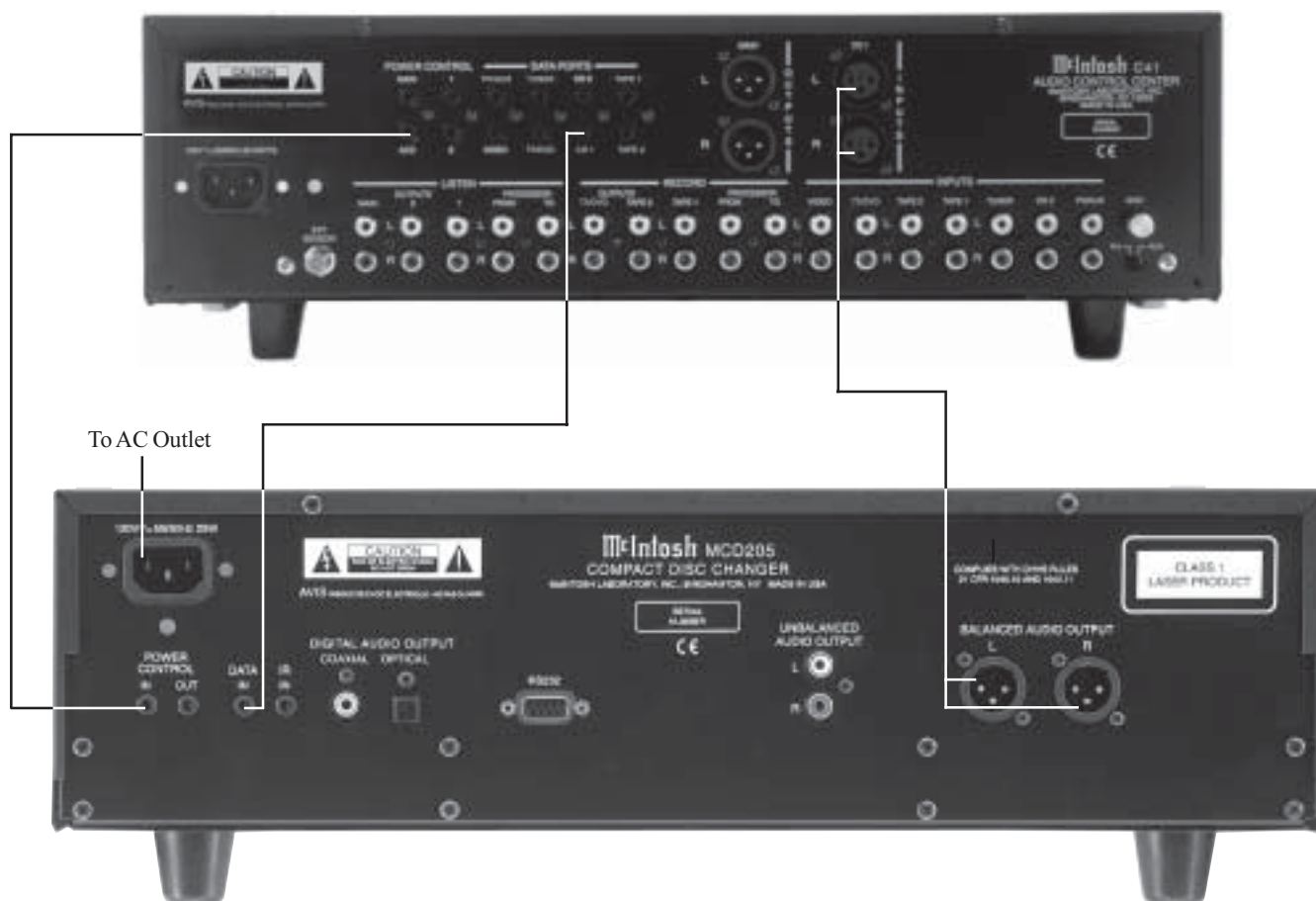

Open and Close the Disc Door for loading or unloading discs

Disc Door opens to permit the loading and unloading of a disc

Front Panel Display

POWER Switch turns all AC power completely ON or OFF

Standby Power On Light

IR Sensor receives commands from a remote control



Activates random Playback of tracks and/or discs

Move forward one track at a time

Use to pause during Playback

STANDBY/ON Push-button turns the MCD205 ON or OFF (Standby)

Selects desired disc

Move back one track at a time

Stops disc Playback

Starts disc Playback

Indicates the Program Track Play Mode is active

Indicates when a pause is inserted between Playback of Tracks

Indicates when the Time Display is showing the Remaining Time

Indicates the number of tracks on the disc

Indicates Track Number

Indicates the current Track Time, Remaining Track Time, Total Disc Playing Time and various Programming information

Indicates Disc Number



Indicates the Random Track Play Mode is active

Indicates when in the Pause Mode

Indicates when one track selection is deleted from the Program

Indicates when a Disc is loaded and flashes when the disc is selected or playing

Indicates when in the Play Mode

Indicates when the Repeat Play Mode is active

Indicates when all tracks are deleted from the Program

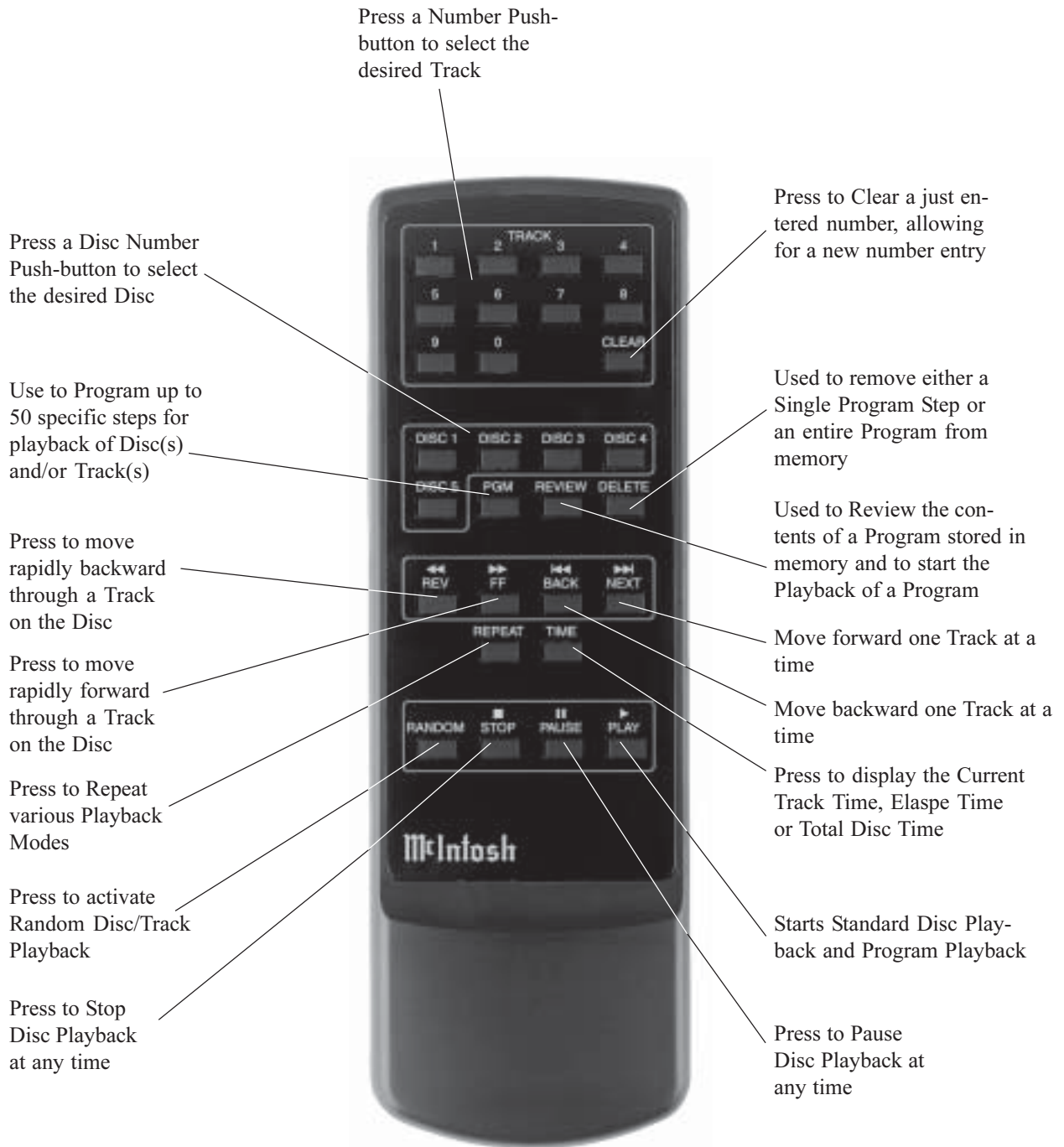

How to Operate the Remote Control

Numbered Push-buttons

Press a NUMBER Push-button (1 through 9) followed by pressing the PLAY Push-button to directly access the desired disc track. Track numbers above 9 require the pressing of two NUMBER Push-buttons followed by the PLAY Push-button. For example, press the NUMBER Push-button 1, then the NUMBER Push-button 2 followed by pressing the PLAY Push-button for track 12.

Clear

Press CLEAR to erase a just entered number allowing for a new number to be entered as part of Direct Track Selection or Programming.

Disc Number

Press the appropriate DISC Number Push-button for selecting various disc functions.

Program

The PGM(Program) Push-button is used to enter desired Disc/Track Selections into memory for Playback. Refer to page 18 for additional information on Programming.

Review

Press the REVIEW Push-button to display the contents of the Program Stored in memory.

Delete

Press the DELETE Push-button to remove from memory a Program Step or an entire Program that has been stored.

Play

Press the PLAY Push-button to start Playback of the currently selected disc or a stored Program.

Time

Pressing the TIME Push-button will either display the Current Track Time, Remaining Time or Total Disc Time.

Pause

Press the PAUSE Push-button to momentarily stop Playback operation at any time. Press the PLAY Push-button to resume Playback of the disc.

Back and Next

Press the NEXT Push-button to move forward or the BACK Push-button to move backward one track at a time.

REV and FF

Press the REVerse Push-button or FF(Fast Forward) Push-button to start moving rapidly through a track.

Note: Audio level is automatically reduced during this operating mode.

Stop

Press the STOP Push-button to stop the disc playing.

Alternate Remote Control Push-button Functions

Most basic MCD205 Operating Functions can be performed with Remote Controls of McIntosh A/V Controllers or Preamplifiers and McIntosh Keypads. Additional MCD205 functions can be performed with other Remote Controls by using push-buttons that are labeled differently from the Compact Disc Remote Control. The chart below lists the MCD205 operations that can be performed by these different pushbuttons on Remote Controls of other McIntosh products.

Other McIntosh Remote Control Devices		
MCD205 Function	Handheld Remote	WK2 Keypad
Disc Select	AM	-
Track	FM	-
Fast Forward	Channel Up	Seek Up
Reverse	Channel Down	Seek Down
Pause	E	-
Random	ACC-ON	-
Repeat	ACC-OFF	-

McIntosh

How to Operate the MCD205

Press the POWER switch to ON, the Red LED above the STANDBY/ON Push-button lights to indicate the MCD205 is in Standby Mode. To Switch On the MCD205 press the STANDBY/ON Push-button. The Front Panel Display will indicate that no discs are loaded in the MCD205. Refer to figures 1 and 2.

Notes: The first time AC Power is applied (or if all power has been OFF to the MCD205 for a period of time) the MCD205 will perform a Self-Check Operation. For normal operation, switch the MCD205 On and Off with the Standby/On Push-button. When the MCD205 Power Control Jack is connected (via a cable) to a McIntosh Control Center, A/V Multizone System Controller or Preamplifier, the MCD205 will automatically switch ON and OFF. If the Disc Changer is not going to be used for an extended period of time, turn Off all AC Power with the Power Switch.

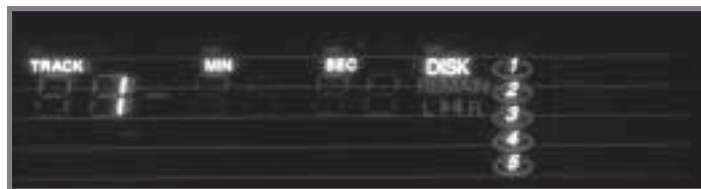

Figure 1

Loading Compact Discs

The MCD205 Compact Disc Changer has the ability to safely handle up to five discs at one time. Before inserting discs into the MCD205 please read General Notes Number 5 through 8 found on pages 4 and 5 for important operating information. In the steps below, two Compact Discs will be loaded into the MCD205.

1. Press the Front Panel OPEN/CLOSE Push-button and the Disc Door will open. Refer to figures 2 and 3.

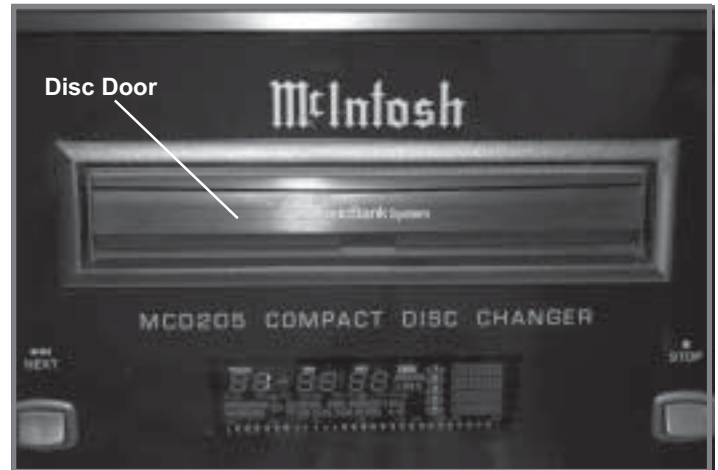

Figure 3

2. The Disc Loading Slot is now visible and permits the insertion of a Disc into the MCD205. Refer to figure 4.



Figure 4



Figure 2

3. Insert the disc into the Loading Slot. Refer to figure 5.
Note: The Disk Number that is flashing on the Front Panel Display will indicate which Changer Disc Slot the Disc will be loaded into. Refer to figure 1.

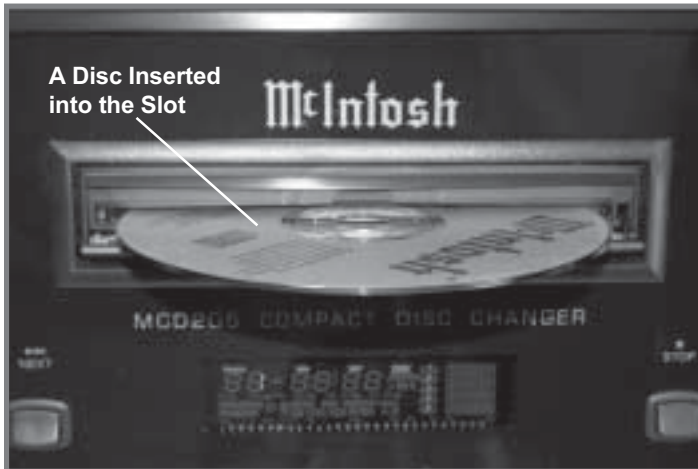

Figure 5

4. Give the front center edge of the disc a slight push. Refer to figure 6.



Figure 6

5. The MCD205 Changer Mechanism will draw the Disc into the Changer and the Disc Door will close. Refer to figure 7.
6. Press the Front Panel DISC SELECT Push-button. The Front Panel Display, Disk Number 2 will now be flashing on the Front Panel Display and the Disk Number 1 will have an Oval Disk Symbol around it, indicating there is a disc loaded into Slot Number One of the Changer. Refer to figure 8.
7. Repeat steps 1 through 5 to load the second disc into the MCD205.
Note: Three more discs may be loaded at this time if desired, by repeating steps 1 through 6. Playing of



Figure 7



Figure 8

the first two already loaded discs may begin by pressing the PLAY Push-button at this time.

Unloading Compact Discs

The steps for removing discs from the MCD205 Compact Disc Changer is similar to the Loading Disc Process, except in reverse. In the Steps below the two Compact Discs that were previously loaded into the MCD205 will now be removed.

1. Press the Front Panel STOP Push-button if a Disc is playing.
2. Press the DISC SELECT Push-button several times until the Front Panel Disk Number 1 is flashing.
3. Press the OPEN/CLOSE Push-button and Disk 1 will be ejected from the MCD205 Changer Mechanism. Remove the disc from the Disc Loading Slot by grasping the outside edges of the disc.
Note: If a disc has been ejected by mistake, just give the Front Center Edge of the Disc a slight push, to have it reloaded into the Changer Disc Slot. Do not Press the Front Panel OPEN/CLOSE Push-button, as this will not draw the Disc back into the Changer and the Top Edge of the Door might mar the playing surface of the Compact Disc.
4. Press the DISC SELECT Push-button once. The Disc Door will close and the Changer Mechanism will now eject the second Disc.
Note: A different Compact Disc may now be loaded into the second slot.

Standard Disc Playback

Press the Front Panel DISC SELECT Push-button to select the desired disc. Press the PLAY▶ Push-button and the disc will start playing. The Front Panel Display will indicate the current Track Number, the Time into the Track and an Arrow Head. Refer to figure 9.

When all of the tracks on that disc have played the MCD205 will stop, unless there are more discs in the Changer. If there are additional discs with higher Disc Numbers than the disc that just finished playing, they will also play once. Discs in Changer Slots with lower numbers than the disc that just finished playing, will not play. Refer to figures 9 and 10.

Note: If the Repeat Mode is active the MCD205 will continuously play all the discs in the Changer. The push-buttons on the Remote Control may also be used for Selecting and Playing Discs. Refer to figure 12.



Figure 9

Direct Track Selection

To select a specific track on a Compact Disc perform the following using the MCD205 Remote Control.

1. Press the DISC NUMBER Push-button to select the desired Disc. Refer to figure 12.
2. Press the NUMBER Push-button to select the desired Track.

Notes: If the desired Track Number is higher than 9, first press the NUMBER Push-button for the "Tens Digit" followed by the pressing of the NUMBER Push-button for the "Units Digit". The CLEAR Push-button may be used to select a different Track Number.

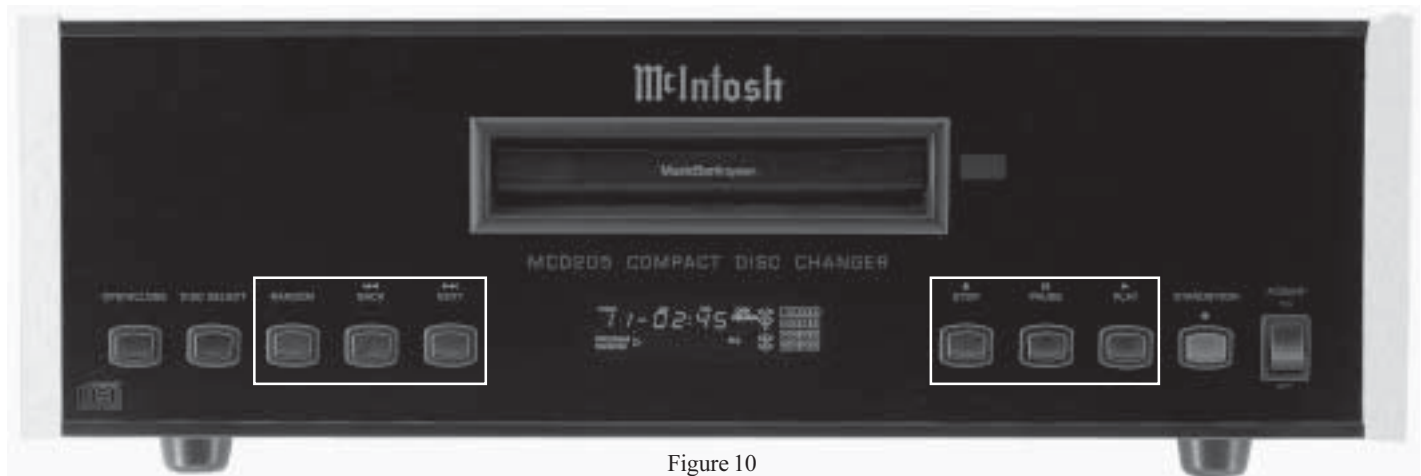

Figure 10

3. Press the PLAY▶ Push-button to start playback of the desired Track.

Disc Pause

While a Disc is playing, press the PAUSE Push-button to temporarily stop playback. To cancel the Pause Mode, press the PLAY Push-button and the disc will resume playing. The Front Panel Display will indicate that the MCD205 is in Pause Mode with double vertical rectangles positioned to the right of the Play Triangle. Refer to figure 11.



Figure 11

Stop Mode

Press the STOP■ Push-button at any time to stop Disc Playback. If the MCD205 is in Random and/or Program Modes of Playback, pressing the STOP Push-button will stop playing of the current disc and cancel the Random and/or Program Modes of Playback.

Back Track

Pressing the BACK◀◀ Push-button while a Disc is playing will either return playback to the beginning of the same Track or to the previous Track.

If the push-button is pushed once within the first three seconds of the playback of the current track, the previous track will start playing. When the push-button is pushed twice, the track before the previous track will start playing.

When the push-button is pushed once after the first three seconds of the track, the beginning of the same track will start again. If the push-button is pushed twice, the previous track will start playing. Holding down the push-button will

allow for rapid selection of the desired Track.

Next Track

For each press of the NEXT **▶▶▶** Push-button the MCD205 will advance to the next Track. Holding down the push-button will allow for rapid selection of the desired Track.

Fast Forward or Reverse

Press the FF (Fast Forward) **▶▶▶▶** or REV (Reverse) **◀◀◀◀** Push-buttons to move back and forth rapidly through a Track on a disc. The accelerated sound will be audible during this operation, at a reduced volume level. Releasing the push-button will return playback to normal speed and volume level.

Repeat Mode

This allows continuous playback of all the Discs/Tracks in the Changer when the MCD205 is in the Standard Play Mode. If either the Random and/or Program Modes of Playback are active, they will also play on a continuous basis.

1. Press the REPEAT Push-button once to activate the Repeat Mode. The Front Panel Display will indicate the Repeat Mode is active. Refer to figure 12.
2. Press REPEAT MODE once again to cancel the Repeat Mode.



Figure 12

Random Play Mode

The MCD205 Compact Disc Changer has the ability to playback Discs and Tracks in a random order during the Standard Disc Playback Mode. Refer to figure 13.

1. Press the RANDOM Push-button to activate the Random Play Mode.
2. Pressing the RANDOM Push-button again, after the Random Play Mode has started, will advance the Changer to playback of the next Random Track.



Figure 12

3. To cancel the Random Play Mode press the STOP Push-button.

Notes: The part of the Front Panel Display that indicates the number of tracks on a disc will momentarily change into a "Flashing Display of Alternating Rectangles around the Track Numbers" when the Random Mode is first activated and between Tracks/ Discs. When the MCD205 is in the Program Play Mode, the Random Play Feature can not be activated.



Figure 13

Time Display

The Front Panel Display can indicate three different Disc/Track Time Displays; Elapsed Time, Remaining Time and Total Disc Time along with the Total number of Tracks. Refer to figure 14.

Press the TIME Push-button once to display the Remaining Track Time. Refer to figure 15. A second press of the push-button and the display will indicate the Total Disc Time along with the number of Tracks. Refer to figure 16.

Note: When the MCD205 is in the Program Playback Mode or Random Playback Mode, the Front Panel Display will only indicate the Elapsed Time and Remaining Time.



Figure 14



Figure 15



Figure 16

Program Playback

The MCD205 has the ability to store 50 different Program Steps for playback in the desired order from the 5 Discs that are loaded in the Changer Mechanism. A Program Step can consist of either a Single Track Selection or an entire Disc.

In order to program tracks from a disc, it is first necessary that the Table of Contents (TOC) which contains the number of tracks and track duration for each disc is stored into memory. The reading of this information occurs when each disc first starts playing. There is another way for the Table of Contents to be read into memory without actually having to play each disc. Refer to Programming Step 2.

Note: The MCD205 Remote Control is needed for Programming Discs/Tracks for the desired playback.

Programming Selections without Playing Discs

1. Press the DISC SELECT Push-button to verify that the Table of Contents has been read into memory for each disc that Tracks will be programmed from. The Front Panel Display in figure 17 indicates two Discs are loaded and the TOC for Disc one is not read. If any of the discs need to have their TOC read, perform step 2; if not proceed to step 3.

Notes: The Active Disc Number is indicated by a "Flashing Oval Symbol" encircling the Disc Number. The Table of Contents Information is indicated on the right side of the MCD205 Front Panel Display.



Figure 17

2. Press the DISC SELECT Push-button to select the first disc that needs the TOC to be read. Refer to figure 18. Press the PAUSE Push-button, about five seconds later the TOC Information will be indicated on the Front Panel Display. Refer to figure 19. Press the DISC SELECT Push-button to read the next disc's TOC. Continue that process until all the discs TOCs have been read. Press the STOP Push-button to cancel the Pause Mode.
3. Press the Disc Number Push-button to select the desired Disc. Refer to figure 19 and 23.



Figure 19

4. Press the Number Push-button to select the desired Track. Refer to figure 20.

Note: If an undesired Number Push-button is pressed, it can be removed by pressing the CLEAR Push-button.



Figure 20

5. Press the PGM (Program) Push-button to enter the selected Disc and Track into memory. Refer to figure 20.
6. Repeat steps 3 through 5 until all the desired selections are entered into memory.
7. Proceed to "Playback of a Program".



Figure 18

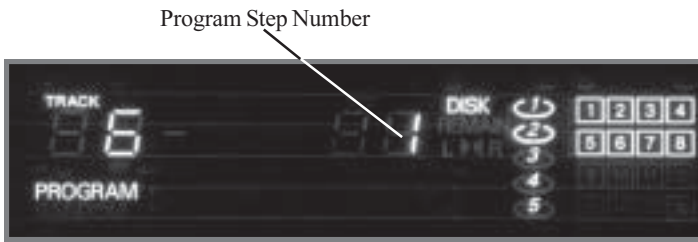

Figure 21

Programming Selections while Playing Discs

1. Press the PGM (Program) Push-button to enter the Track that is playing into memory.
2. Repeat Step 1 for as many tracks as desired. If there is desire to add tracks from other discs already loaded into the MCD205 perform the following steps, if not proceed to step 7.
3. Press the Disc Number Push-button to select the desired Disc.
4. Use the NEXT Push-button to rapidly scan through tracks to find the desired Track(s).
5. Press the PGM (Program) Push-button to enter into memory the Track that is playing.
6. Repeat steps 3 and 4 until all the desired selections are entered into memory.
7. Proceed to “Playback of a Program”.

Programming an Entire Disc

1. Press the Disc Number Push-button to select the desired Disc and press the same Disc Number Push-button a second time.

Notes: The Programming of an entire Disc into memory can be performed with either a disk playing or not playing. It can also be performed at any time during the programming of individual Track Selections. Although a Disc may have many Tracks on it, Programming an entire Disc only requires one Program Step in memory.



Figure 22

2. Press the PGM (Program) Push-button to enter the Disc into memory. Refer to figure 22.
3. Repeat steps 1 and 2 until all the desired whole discs are entered into memory.
4. Proceed to “Playback of a Program”.

Playback of a Program

1. Press the REVIEW Push-button.

2. Press the PLAY ► Push-button to start Playback of the Program.

Review of a Program

1. Press the REVIEW Push-button. The Front Panel Display will indicate the Track Number (or the letters “AL” for an entire disc) and the Program Step Number to the left of the word “DISC”.
2. To Review any additional Program Steps, continue to press the REVIEW Push-button and the Front Panel Display will indicate the remaining Program Steps.



Figure 23

Removing a Program Step

1. Press the REVIEW Push-button to select the desired Program Step that is to be Deleted.
2. Press the DELETE Push-button once to remove the unwanted Program Step. Refer to figures 24 and 26.



Figure 24

3. To remove additional Program Steps repeat Steps 1 and 2.
4. Proceed to "Playback of a Program".

Remove an Entire Program

Press the REVIEW Push-button, and within 5 seconds press the DELETE Push-button twice. Refer to figure 25.



Figure 25

Modify a Program without Playing Discs

1. If a Disc is Playing, press the STOP Push-button.
2. Press the Disc Number Push-button to select the desired Disc.
3. Use the NEXT (or BACK) Push-button to rapidly scan through tracks to find the desired Track.
4. Using the REVIEW Push-button, select the Program Step to be changed.
5. Press the PGM (Program) Push-button to enter the change into memory.
6. Using the REVIEW Push-button scan through the Program Steps to verify the Program change.
7. Proceed to "Playback of a Program" on page 19.

Modify a Program while Playing Discs

1. Place the MCD205 in the Standard Play Mode.
2. Select the desired Disc and Track to be Programmed.
3. Using the REVIEW Push-button, select the Program Step to be changed.
4. Press the PGM (Program) Push-button to enter the change into memory.

5. Using the REVIEW Push-button scan through the Program Steps to verify the Program change.
6. Proceed to "Playback of a Program" on page 19.

Resetting of Microprocessors

In the event that the controls of the MCD205 stop functioning, place the POWER Switch in the OFF position for 5 seconds, then back ON. This will reset the MCD205 Microprocessors.



Figure 26

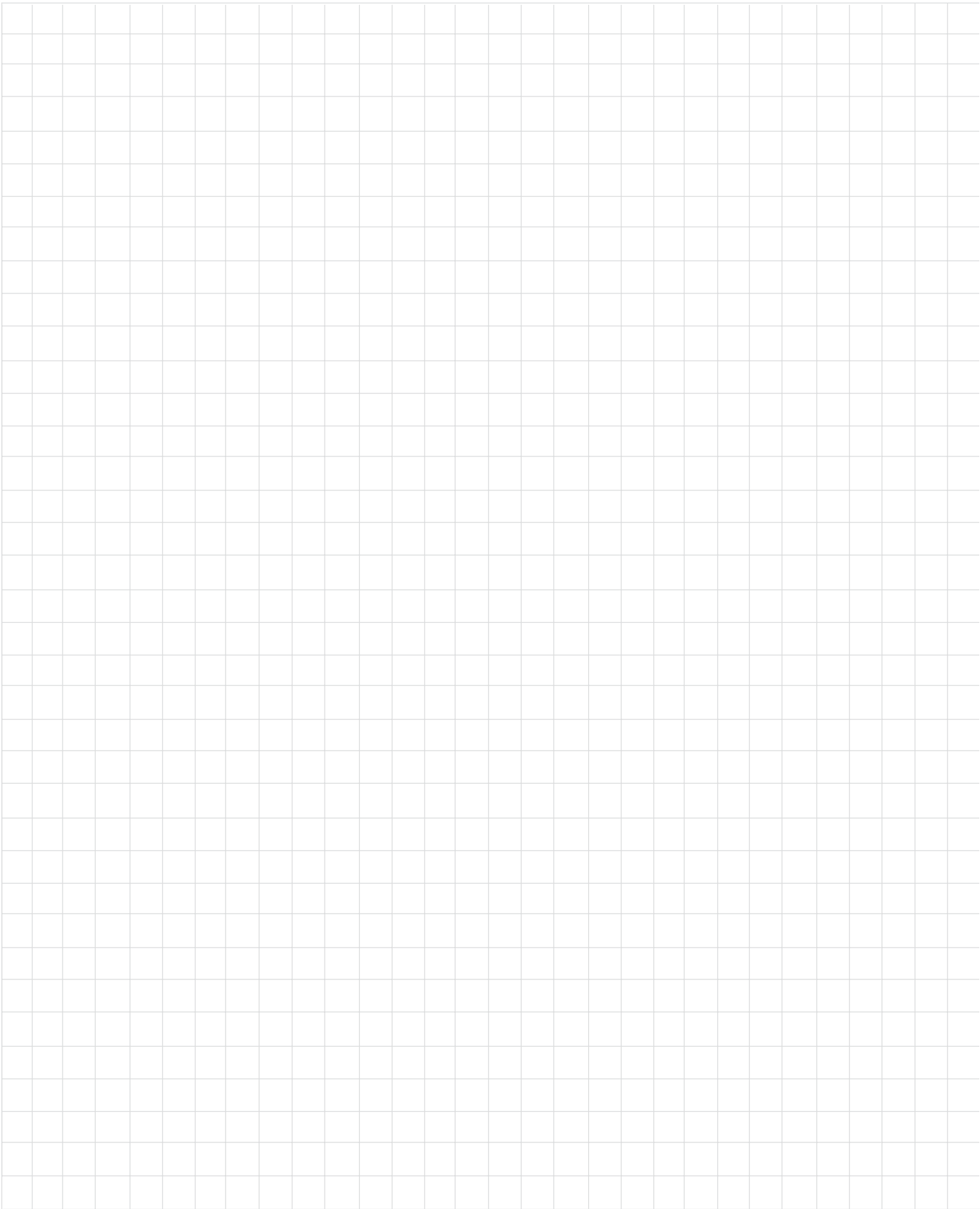

Specifications

Frequency Response

+0, -0.5 dB 5Hz to 20,000Hz

Signal to Noise Ratio

108dB (IHF A-weighted)

Dynamic Range

100dB

Harmonic Distortion

0.002% maximum

Channel Separation

105dB

Maximum Output level

2.0Vrms Balanced

2.0Vrms Unbalanced

Output Impedance

600 ohms Balanced

600 ohms Unbalanced

Sampling Frequency

44,100Hz

D/A Converter

24-bit dual converters with 8 times oversampling digital filter

Error Correction

CIRC

Quantization

16-bit linear

Digital Output

Optical: -15dbm to -21dbm

Coaxial: 0.5V p-p/75 ohm

Transport Signal Readout Type

Semiconductor Optical Laser

Disc Rotational Velocity

200 to 500rpm (constant linear velocity)

Wow and Flutter

Below current measurement limits

Power Requirements

100 Volts, 50/60Hz at 25 watts

110 Volts, 50/60Hz at 25 watts

120 Volts, 50/60Hz at 25 watts

220 Volts, 50/60Hz at 25 watts

230 Volts, 50/60Hz at 25 watts

240 Volts, 50/60Hz at 25 watts

Note: Refer to the rear panel of the MCD205 for the correct voltage.

Dimensions

Front Panel: 17-1/2 inches (44.5cm) wide, 5-3/8 inches (13.7cm) high, depth behind front mounting panel is 15 inches (38.1cm) including clearance for connectors. Panel clearance required in front of mounting panel is 3/4 inch (1.9cm).

Note: When a CD Disc is inserted or ejected, the panel clearance required in front of mounting panel is 3-3/4 inches (9.5cm).

Weight

21 pounds (9.5Kg) net, 35 pounds (15.9Kg) in shipping carton

Packing Instructions

In the event it is necessary to repack the equipment for shipment, the equipment must be packed exactly as shown below. It is very important that the four plastic feet are attached to the bottom of the equipment. This will ensure the proper equipment location on the bottom pad. Failure to do this will result in shipping damage.

Use the original shipping carton and interior parts only if they are all in good serviceable condition. If a shipping carton or any of the interior part(s) are needed, please call or write Customer Service Repair Department of McIntosh Laboratory. Please see the Parts List for the correct part numbers.

Quantity	Part Number	Description
1	034075	Shipping carton only
4	033837	Foam end cap
1	034076	Inside carton only
1	033726	Top pad
1	034036	Bottom pad
1	034077	Inner carton pad
4	017218	Plastic foot
4	100159	#10-32 x 3/4" screw
4	104083	#10 x 7/16" Flat washer

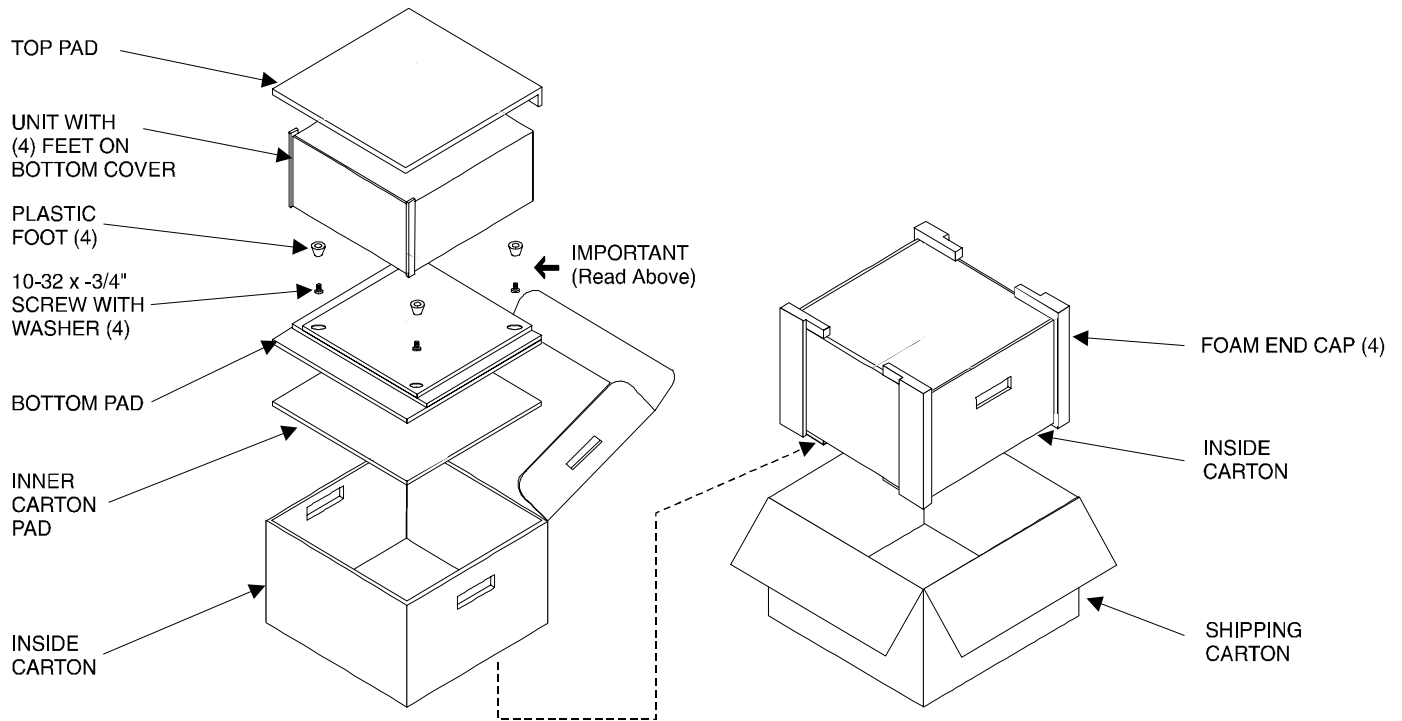

McIntosh[®]

McIntosh Laboratory, Inc.
2 Chambers Street
Binghamton, NY 13903

McIntosh Part No. 040808